

TECHNICAL DATA

#DGB-18/2410 18" OR 24" x 1 1/4" DECORATIVE GRAB BAR

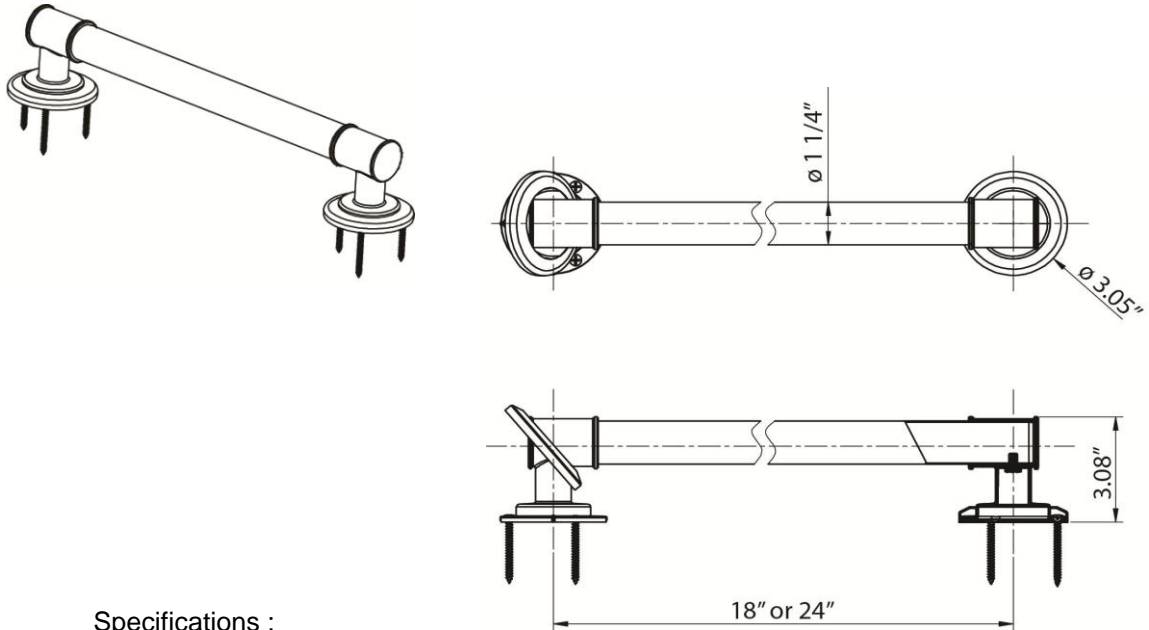

Specifications :

- \* Safety Bar ~ Material : #304 Stainless Steel Bar
  - ~ Finish : Polished Bright or Satin
  - ~ Bar Diameter : 1 1/4"
  - ~ Length : 18" or 24"
- \* Mounting Brackets ~ Material : Zinc alloy
  - ~ Finish : Electro-plated
- \* 1-1/2 In. Wall Clearance
- \* #10 x 2" Stainless Steel Mounting Screws x 6 pcs (Included)
- \* ADA Compliant
- \* Weight Capacity : 500 lbs

Arista Safety Products



WT International Inc.

4100 Cedar Commercial Dr., Cedar Springs, MI. 49319